

BIOLOGY

9700/12

Paper 1 Multiple Choice

May/June 2015

1 hour

Additional Materials: Multiple Choice Answer Sheet
 Soft clean eraser
 Soft pencil (type B or HB is recommended)



READ THESE INSTRUCTIONS FIRST

Write in soft pencil.
Do not use staples, paper clips, glue or correction fluid.
Write your name, Centre number and candidate number on the Answer Sheet in the spaces provided unless this has been done for you.
DO NOT WRITE IN ANY BARCODES.

There are **forty** questions on this paper. Answer **all** questions. For each question there are four possible answers **A, B, C** and **D**.
Choose the **one** you consider correct and record your choice in **soft pencil** on the separate Answer Sheet.

Read the instructions on the Answer Sheet very carefully.

Each correct answer will score one mark. A mark will not be deducted for a wrong answer.
Any rough working should be done in this booklet.
Electronic calculators may be used.

This document consists of **17** printed pages and **3** blank pages.

1 What is the diameter of a typical plant cell?

- A $4.0 \times 10^1 \mu\text{m}$
- B $1.0 \times 10^0 \mu\text{m}$
- C $4.0 \times 10^2 \text{nm}$
- D $1.0 \times 10^2 \text{nm}$

2 A specimen is viewed under a microscope using green light with a wavelength of 510 nm.

If the same specimen is viewed under the same conditions, but using red light with a wavelength of 650 nm instead, what effect will this have on the magnification and on the resolution of the microscope?

	magnification	resolution
A	decreased	remains the same
B	increased	increased
C	remains the same	decreased
D	remains the same	increased

3 What is the function of plasmodesmata in plant cells?

- A to act as a barrier to water soluble substances
- B to allow active transport of ions and sucrose between cells
- C to allow the symplastic movement of substances between cells
- D to enable cells to recognise each other

4 Which size of ribosome is found in both chloroplasts and mitochondria?

- A 60S
- B 70S
- C 80S
- D 90S

5 Which function is correct for the description of the cell structure?

	function	cell structure
A	organises microtubules to produce the spindle	membrane-bound sacs, arranged as a flattened sac
B	packages hydrolytic enzymes used in cell	non-membrane bound cylindrical structures
C	synthesises lipids	membranes which surround an enclosed inner cavity
D	synthesises polypeptides	membrane bound spherical structure

6 Ribosomes consist of two subunits, each containing rRNA. An analysis of **all** the 70S ribosomes from a single cell of the bacterium, *Escherichia coli*, showed that there were:

- 38 000 rRNA molecules
- 2 main types of rRNA molecule
- 19 000 copies of each type of rRNA molecule

How many 70S ribosomes were there in the *E. coli* cell?

- A** 9500 **B** 19 000 **C** 38 000 **D** 76 000

7 Which type of bond holds together an α -helix or β -pleated sheet of a protein?

- A** disulfide
B hydrogen
C ionic
D peptide

8 What describes only the quaternary structure of haemoglobin?

- 1 α -helix
- 2 a dipeptide
- 3 a globular structure
- 4 the specific order of amino acids
- 5 four polypeptide chains joined together

- A** 1, 2 and 3 **B** 2, 4 and 5 **C** 1 and 4 **D** 5 only

9 The statements are about the properties of water.

- 1 ability to form hydrogen bonds with other molecules
- 2 less dense when frozen
- 3 able to hold a lot of heat

What allows a small insect to rest on the surface of a pond?

- A** 1 and 2 **B** 2 and 3 **C** 1 only **D** 2 only

10 Which bonds hold together the structure of cellulose?

- 1 glycosidic
- 2 hydrogen
- 3 ionic

A 1, 2 and 3 **B** 1 and 2 only **C** 1 and 3 only **D** 2 and 3 only

11 Which bonds are found in glycogen?

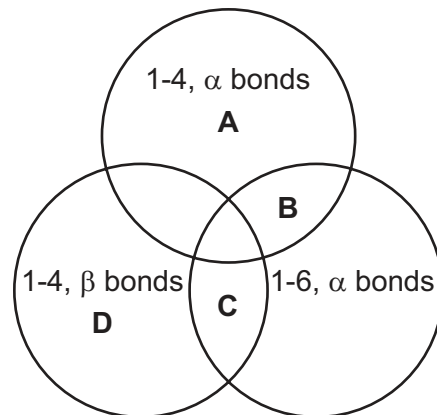

12 Solutions of biological molecules are tested for sugars. The table shows the colours of the solutions after testing.

solution	heated with Benedict's solution	boiled with hydrochloric acid, neutralised, then heated with Benedict's solution
1	blue	orange
2	green	green
3	yellow	red

Which may contain non-reducing sugars?

A 1, 2 and 3 **B** 1 and 2 only **C** 1 and 3 only **D** 2 and 3 only

13 Which levels of protein structure are always involved when competitive and non-competitive inhibitors bind to enzymes?

	competitive	non-competitive
A	primary, secondary and tertiary	secondary
B	quaternary and tertiary	quaternary and tertiary
C	secondary	primary and tertiary
D	tertiary	tertiary

14 Which statements are true about the optimum temperature of **all** enzymes?

- 1 It is the temperature at which the enzymes work best.
- 2 It is the highest temperature at which the enzyme will work.
- 3 It is between 35 °C and 40 °C.

A 1, 2 and 3 **B** 2 and 3 only **C** 1 only **D** 3 only

15 Which description of cell surface membrane permeability is correct?

- A** An increase in the concentration of cholesterol molecules in the cell surface membrane can increase its permeability to hydrophilic substances.
- B** Cell surface membrane permeability to large hydrophilic molecules is high and can be increased by membrane transport proteins involved in facilitated diffusion.
- C** The permeability of the cell surface membrane to ions is increased with an increase in the proportion of saturated fatty acids in the phospholipids.
- D** Without the presence of carrier and channel membrane proteins, the cell surface membrane has a low permeability to large polar molecules.

16 The diagram represents a cell surface membrane.

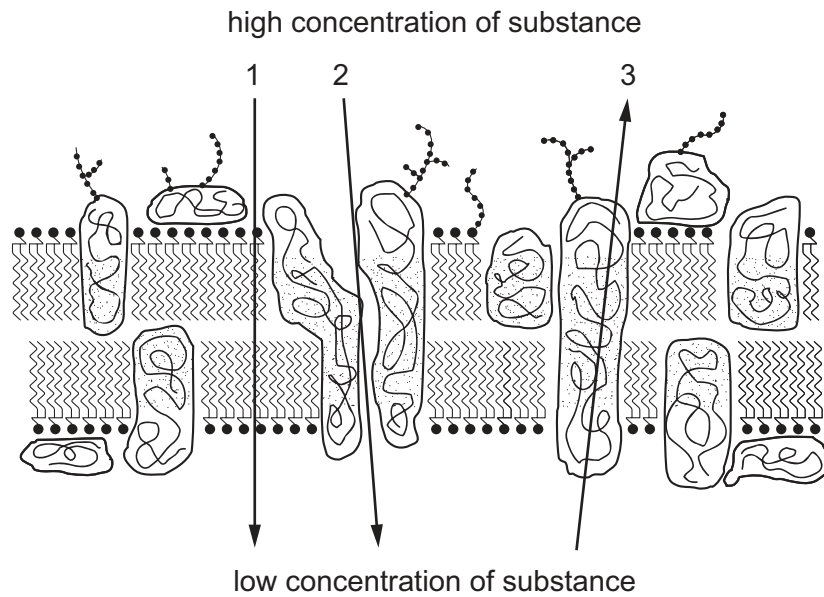

Three pathways through the membrane are shown.

Which process is represented by each arrow?

	1	2	3
A	active transport	diffusion	facilitated diffusion
B	diffusion	active transport	facilitated diffusion
C	diffusion	facilitated diffusion	active transport
D	facilitated diffusion	diffusion	active transport

17 Which set of factors will produce the **most** fluid cell surface membrane?

	an increase in
A	<ul style="list-style-type: none"> • proportion of phospholipids with saturated fatty acid chains • distance between phospholipid molecules
B	<ul style="list-style-type: none"> • proportion of long fatty acid chains • proportion of phospholipids with unsaturated fatty acid chains
C	<ul style="list-style-type: none"> • proportion of long fatty acid chains • temperature
D	<ul style="list-style-type: none"> • proportion of phospholipids with unsaturated fatty acid chains • temperature

18 The protein p53 is produced in a cell in response to DNA damage.



A scientist exposed three groups of cells, X, Y and Z, to different conditions.

group of cells	conditions cells were exposed to
X	ionising radiation
Y	ultra-violet light
Z	nicotine

In which groups of cells would the scientist find large quantities of p53 mRNA?

- A** X, Y and Z **B** X and Y only **C** Y and Z only **D** Y only

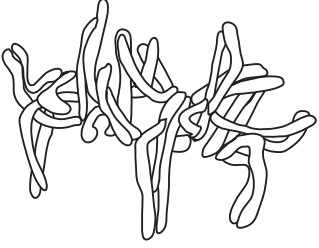
19 Which row is correct?

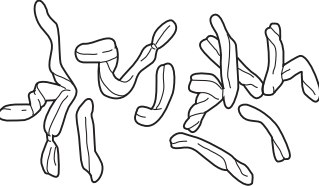
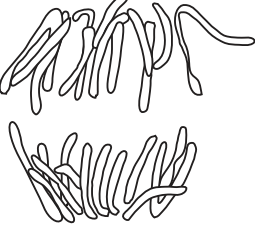
	diagram	stage
A		interphase
B		metaphase
C		telophase
D		anaphase

20 What is needed to transcribe DNA?

- A** DNA ligase
- B** DNA polymerase
- C** ribosomes
- D** RNA polymerase

21 In a ribosome, which bond holds together two adjacent amino acids?

- A disulfide
- B hydrogen
- C ionic
- D peptide

22 The diagram shows part of a DNA molecule.

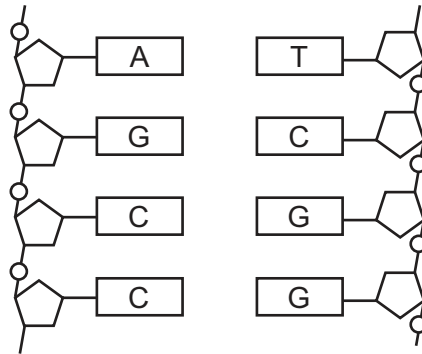

How many hydrogen bonds are involved in holding these strands of DNA together?

- A 11
- B 9
- C 8
- D 4

23 Which features of these cells make them suitable for their function?

	companion cells	xylem vessel elements
A	circulating contents allow transport in both directions	lignified walls provide support
B	cellulose walls provide support	nuclei allow cell division
C	nuclei allow cell division	gaps between cells allow rapid transport
D	numerous mitochondria supply energy	absence of cytoplasm allows mass flow

24 What is the sequence of events in the translocation of sucrose?

- A active loading of sucrose into sieve elements at the source, increased hydrostatic pressure, mass flow, unloading at the sink
- B hydrolysis of storage compounds in sinks, lowered water potential, unloading of sucrose from sieve elements, mass flow from the source
- C lowered pressure in sieve elements at the source, movement of sucrose down the pressure gradient, mass flow down a diffusion gradient to the sink
- D mass flow of dissolved sucrose into the sieve element at the source, lowered hydrostatic pressure, diffusion of sucrose to sink, active unloading

25 Where does water evaporate from during transpiration?

- A inside the guard cells
- B the outer surface of the epidermal cell layer
- C the sub-stomatal cavity
- D the surface of spongy mesophyll cell walls

26 Which changes to the water potential and the volume of liquid in the phloem occur when amino acids are taken out of a sink in a phloem sieve tube?

	water potential in phloem sieve tubes	volume of liquid in phloem sieve tubes
A	higher	decreased
B	higher	increased
C	lower	decreased
D	lower	increased

27 Which reaction takes place in a capillary in the lungs?

- A the formation of carbaminohaemoglobin from carbon dioxide and haemoglobin
- B the formation of carbon dioxide and water from hydrogen carbonate ions and hydrogen ions
- C the formation of carbonic acid from carbon dioxide and water
- D the formation of haemoglobinic acid from haemoglobin and hydrogen ions

28 Which structure is correctly identified?

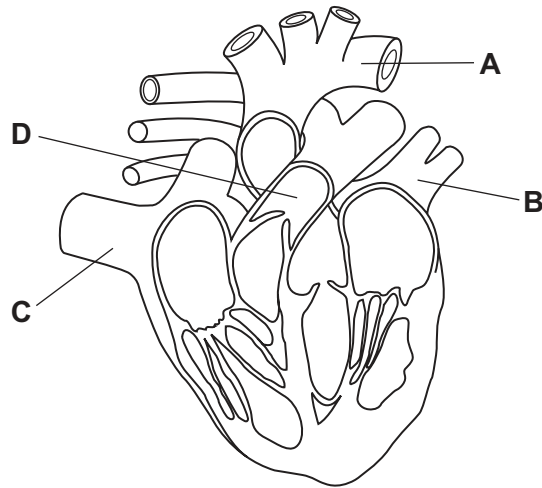

- A aorta
- B pulmonary artery
- C pulmonary vein
- D vena cava

- 29 Resting muscle has a lower respiration rate than active muscle. The graph shows the oxygen dissociation curves for haemoglobin at carbon dioxide concentrations that are found in a resting muscle and an active muscle.

P and Q are at the partial pressures of oxygen found in the lungs.

R and S are at the partial pressures of oxygen found in **either** a resting muscle **or** an active muscle.

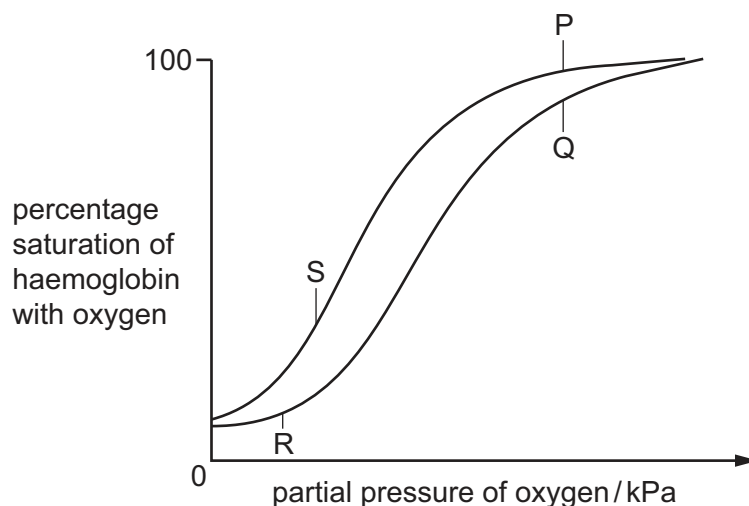

Which statements are correct?

- 1 The % saturation at P minus the % saturation at S represents the amount of oxygen delivered to a resting muscle.
- 2 The % saturation at Q represents the amount of oxygen carried to an active muscle.
- 3 The % saturation at R represents the amount of oxygen required by a resting muscle.
- 4 The % saturation at P minus the % saturation at Q represents the amount of oxygen delivered to an active muscle.
- 5 The % saturation at Q minus the % saturation at S represents the amount of oxygen delivered to a resting muscle.

A 1 and 2 **B** 3 and 4 **C** 1 only **D** 5

- 30 What does **not** help to maximise uptake of oxygen as blood flows through capillaries in the lungs?

- A** Dissociation of carbon dioxide from carboxyhaemoglobin allows more haemoglobin to be available for oxygen binding.
- B** Each haemoglobin molecule can temporarily bind to eight oxygen atoms.
- C** Oxyhaemoglobin formation increases the capacity of red blood cells to transport oxygen.
- D** The binding of the first oxygen molecule to haemoglobin increases the molecule's affinity for binding other oxygen molecules.

- 31 What correctly describes the role of elastic fibres in the lungs?
- A** They allow the walls of stretched alveoli to recoil as air is breathed out.
- B** They increase in the walls of alveoli as a result of the release of the enzyme elastase.
- C** They increase in the walls of the alveoli as emphysema develops.
- D** They prevent the walls of the alveoli from collapsing as air is breathed in.
- 32 The diagram represents a section through the wall of a bronchus (not to scale).

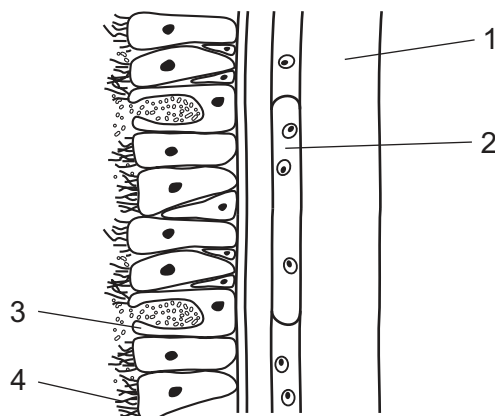

In a person with chronic obstructive pulmonary disease (COPD), what happens in each of the numbered structures?

	1	2	3	4
A	contracts	contracts	inhibited	not affected
B	contracts	not affected	overactive	inhibited
C	relaxes	contracts	inhibited	paralysed
D	relaxes	not affected	overactive	overactive

33 The symptoms of two diseases are listed.

disease 1	disease 2
persistent cough	shortness of breath
pain when breathing	wheezing
loss of weight	fatigue

Which row identifies diseases 1 and 2?

	disease 1	disease 2
A	chronic bronchitis	emphysema
B	emphysema	lung cancer
C	lung cancer	chronic bronchitis
D	lung cancer	emphysema

34 The graph shows the fall in cases of tuberculosis (TB) in a country between 1910 and 2000.

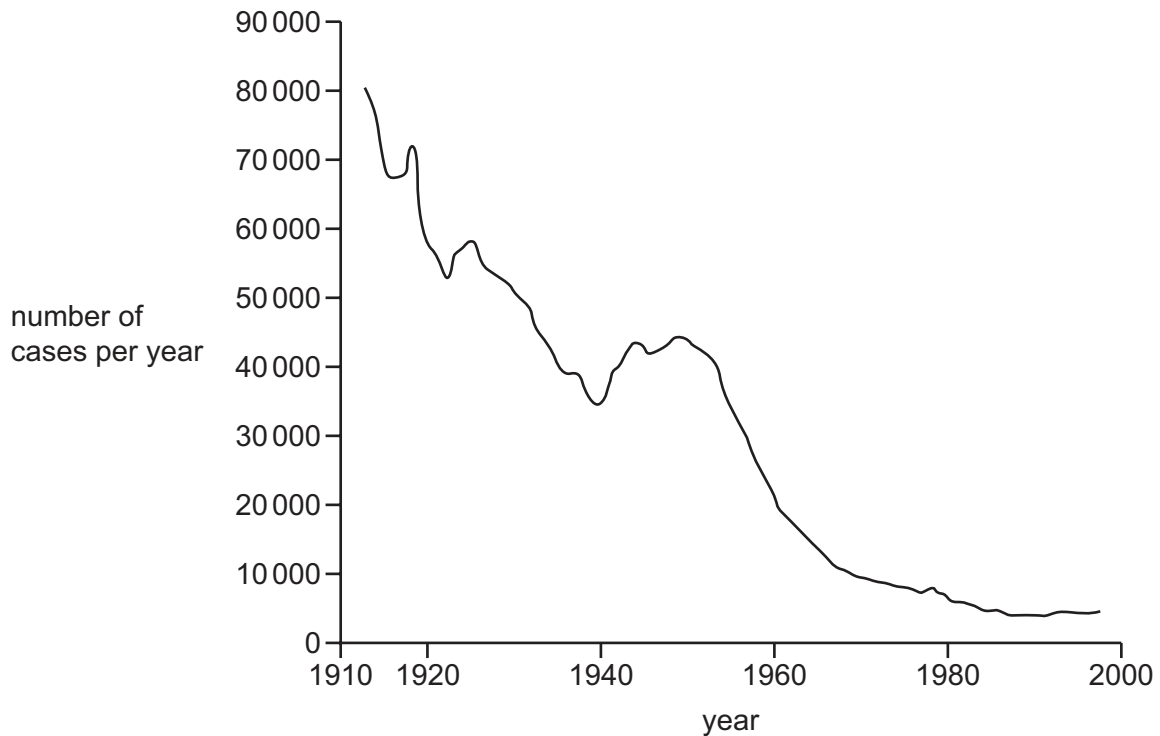

Which factors could have contributed to the fall over this period?

- 1 pasteurisation of milk
- 2 the provision of new housing
- 3 chemical treatment of sewage
- 4 identification of contacts of people infected with TB

A 1, 2 and 4 **B** 2, 3 and 4 **C** 1 and 3 only **D** 1 and 4 only

35 Which row is correct for cholera?

	nature of disease	method of transmission	causative agent (pathogen)
A	infectious	insect vector	species of <i>Plasmodium</i>
B	infectious	water-borne	species of <i>Vibrio</i>
C	non-infectious	insect vector	species of <i>Plasmodium</i>
D	non-infectious	water-borne	species of <i>Vibrio</i>

36 Which action is taken by a B-lymphocyte activated by an antigen?

- A It attaches to the infected cell displaying the antigen and destroys it.
- B It divides repeatedly to form a clone of genetically identical plasma cells.
- C It engulfs the infected body cell which displays the antigen.
- D It secretes cytokines which stimulate T-lymphocytes to produce plasma cells.

37 The synthesis of specific antibodies in response to vaccination is an example of which type of immunity?

	natural	artificial
active	A	B
passive	C	D

38 At which stage of a food chain in a tropical grassland is the energy transfer least efficient?

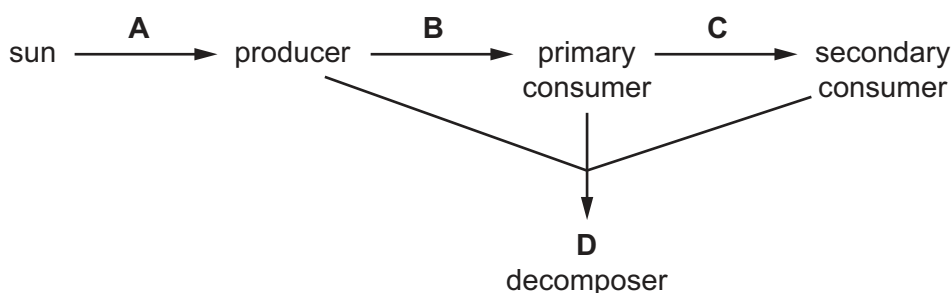

39 A farmer grows a different crop in a field each year for three years.

In the fourth year he grows a leguminous crop, such as clover, and then ploughs this into the soil. The next year he starts the rotation again.

How does the fourth year crop add mineral ions to the soil?

	decomposition	nitrification	nitrogen fixation
A	no	yes	yes
B	yes	no	yes
C	yes	yes	no
D	yes	yes	yes

40 Of the prey consumed by the lion, into which box does the largest amount of energy go?

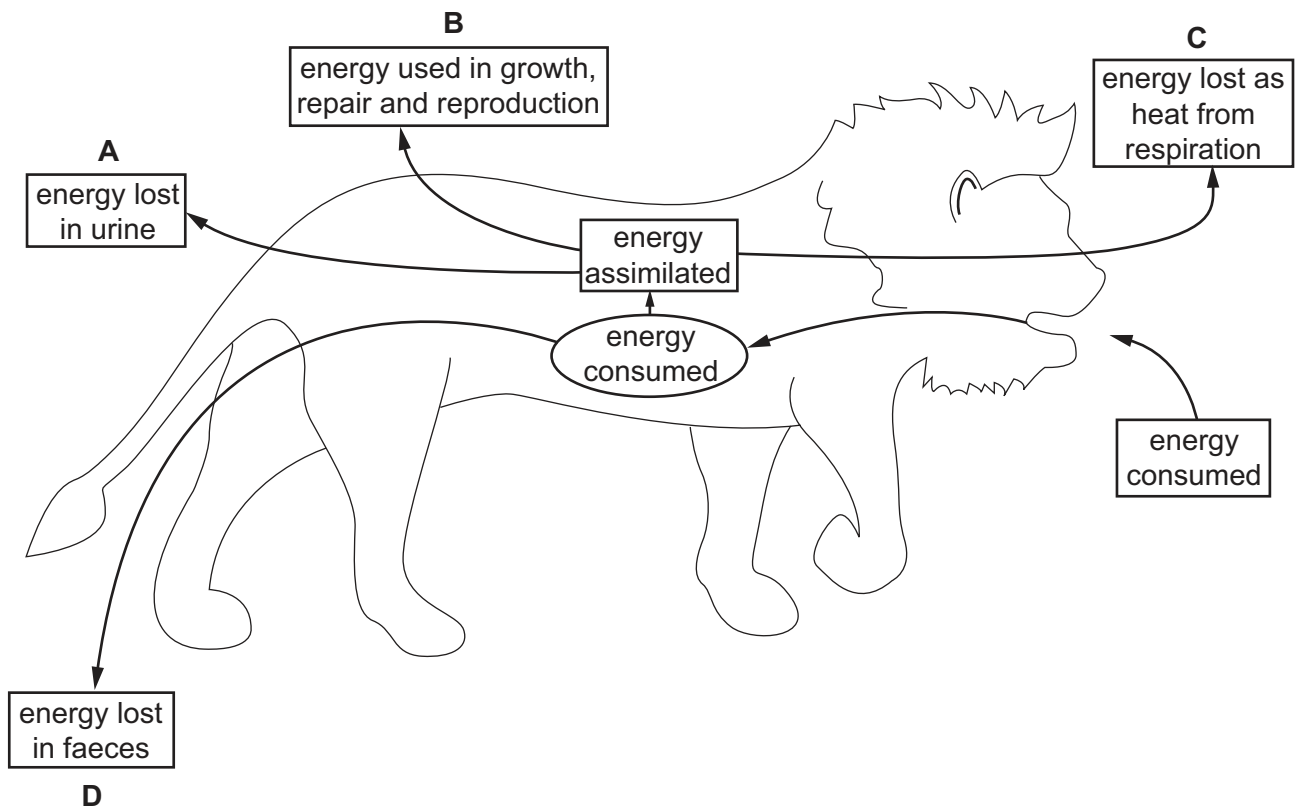

BLANK PAGE

Permission to reproduce items where third-party owned material protected by copyright is included has been sought and cleared where possible. Every reasonable effort has been made by the publisher (UCLES) to trace copyright holders, but if any items requiring clearance have unwittingly been included, the publisher will be pleased to make amends at the earliest possible opportunity.

To avoid the issue of disclosure of answer-related information to candidates, all copyright acknowledgements are reproduced online in the Cambridge International Examinations Copyright Acknowledgements Booklet. This is produced for each series of examinations and is freely available to download at www.cie.org.uk after the live examination series.

Cambridge International Examinations is part of the Cambridge Assessment Group. Cambridge Assessment is the brand name of University of Cambridge Local Examinations Syndicate (UCLES), which is itself a department of the University of Cambridge.